

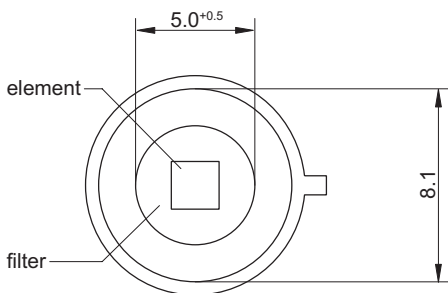

HPS E09E

Pyroelectric Single Element Detector for Measurement Applications

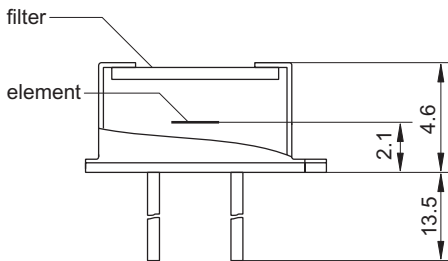
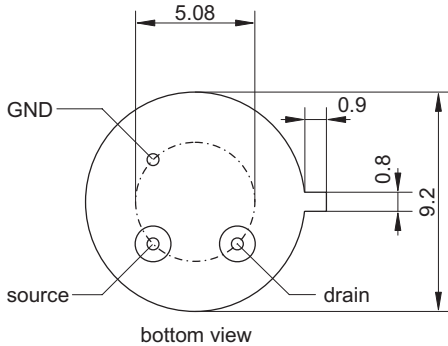

element size	2 mm × 2 mm
aperture	5.0 ^{+0.5} mm
filter ³	Ge* or Si* (8–14 μm)
responsivity ^{1,2}	> 300 V/W
noise ¹	< 150 nV/√Hz
specific detectivity ^{1,2}	> 4 · 10 ⁸ cm√Hz/W
offset voltage	0.4–1.5 V
operating voltage	2–18 V
housing	TO 39
operating temperature	–20 to 60 °C
storage temperature	–20 to 60 °C

- 1) frequency: 10 Hz, detector temperature: 25 °C
- 2) blackbody source temperature: 500 K, filter transmission: 100 %
- 3) other filters on request

