

1 Table of Contents

1 Table of Contents.....	1
2 Maximum Ratings.....	1
3 Electrical Specification.....	2
3.1 RAM Registers 32 x 17bit for Data Readout.....	4
3.1.1 Sensor Voltage V_{TP}	4
3.1.2 Object Temperature T_O	4
3.1.3 Ambient Temperature T_A	4
3.2 EEPROM Memory 32 x 16bit for Parameter Change.....	4
3.2.1 T_{Omax} , T_{Omin} , T_a range.....	5
3.2.2 Emissivity Correction Coefficient.....	5
3.2.3 PWMCTRL.....	5
3.2.4 Config Register1.....	5
3.2.5 SMBus Address.....	6
4 SMBus compatible 2-wire protocol.....	6
4.1 Functional description.....	6
4.2 Differences with the standard SMBus specification.....	6
4.3 Detailed description.....	7
4.3.1 Bus Protocol.....	7
4.3.2 Packet Error Code (PEC) Calculation.....	7
4.3.3 Read Word (depending on the command – RAM or EEPROM).....	7
4.3.4 Write Word (depending on the command – RAM or EEPROM).....	10
4.4 AC specification for SMBus.....	12
4.4.1 Timing.....	12
4.4.2 Bit transfer.....	12
4.4.3 Commands.....	13
5 PWM.....	13
5.1 Single PWM format.....	13
5.2 Extended PWM format.....	14
5.3 Customizing the temperature range for PWM output.....	15
6 Switching Between PWM and SMBus communication.....	15
6.1 PWM is enabled.....	15
6.2 Request condition.....	16
6.3 PWM is disabled.....	16
7 Disclaimer of Liability.....	16

2 Maximum Ratings

Parameter	5V Version	3V Version
Supply Voltage, V_{DD} (over voltage)	7V	5V
Supply Voltage, V_{DD} (operating)	5.5 V	3.6V
Reverse Voltage	0.4V	
Operating Temperature Range, T_A	-40°C .. 125°C	
Storage Temperature Range, T_S	-40°C .. 125°C	
ESD Sensitivity (AEC Q100 002)	2kV	
DC sink current, SDA /PWM pin	25 mA	
DC source current, SDA/PWM pin	25 mA	
DC clamp current, SDA/PWM pin	25 mA	
DC clamp current, SCL pin	25 mA	

Exceeding the absolute maximum ratings may cause permanent damage.
Exposure to absolute-maximum-rated conditions for extended periods may affect device reliability.

3 Electrical Specification

All parameters are preliminary for $T_A = 25\text{ }^\circ\text{C}$, $V_{DD} = 5\text{V}$, $V_{DD} = 3\text{V}$ (unless otherwise specified)

Parameter	Symbol	Test Conditions	Min	Typ	Max	Units
Supplies						
External supply	V_{DD}	5V-Version	4.5	5	5.5	V
External supply	V_{DD}	3V-Version	2.4	3	3.6	V
Supply current	I_{DD}	No load		1	2	mA
Supply current (programming)	I_{DDpr}	No load, erase/write EEPROM operations		1.5	2.5	mA
Analog to Digital Converter						
Effective number of bits	ENOB			17		Bit
Reference voltage	ADC_{REF}		1.1	1.2	1.3	V
Input differential voltage range	V_{IN}	Amplifier bypassed, 0x0FFFF, 0x1FFFF	-0.4	ADC_{REF}	+0.4	V
Amplifier						
Gain	G		3		100	V/V
Input common mode range	V_{INCM}	Linear operation	-0.1	0	+0.1	V
Input referred noise	e_{NOISE}	For gain 100 or 50 and frequency of 2kHz		25		nVrms/Hz ⁻¹
Gain non-linearity	G_{NL}		-0.1		0.1	%
Power Saving Mode (Only available on 3V-Version)						
Power-down supply current	I_{sleep}	no load, 3V-Version only	1	2.5	5	uA
Power-down supply current	I_{sleep}	Full temperature range, 3V-Version only	1	2.5	6	uA
Power On Reset						
POR level	V_{POR}	Power-up, power-down and brown-out, $V_{DD} = 5\text{V}$	2.7	3.0	3.3	V
POR level	V_{POR}	Power-up, power-down and brown-out, $V_{DD} = 3\text{V}$	1.6	1.85	2.1	V
V_{DD} rise time	T_{POR}	Ensure POR signal			3	ms
Output valid (result in RAM)	T_{valid}	After POR		0.15		s
Pulse width modulation¹						
PWM resolution	PWMres	Data band		10		bit
PWM output period	$PWM_{T,def}$	Factory default, internal oscillator factory calibrated		1.024		ms
PWM period stability	$dPWM_T$	Internal oscillator factory calibrated, over the entire operation range and supply voltage	-4		+4	%
Output high Level	PWM_{HI}	$I_{source} = 2\text{ mA}$	$V_{DD}-0.25$			V
Output low Level	PWM_{LO}	$I_{sink} = 2\text{ mA}$			$V_{SS}+0.2$	V
Output drive current	$I_{drive_{PWM}}$	$V_{out,H} = V_{DD} - 0.8\text{V}$, $V_{DD} = 5\text{V}$		7		mA
Output drive current	$I_{drive_{PWM}}$	$V_{out,H} = V_{DD} - 0.8\text{V}$, $V_{DD} = 3\text{V}$		4.5		mA
Output sink current	$I_{sink_{PWM}}$	$V_{out,L} = 0.8\text{V}$, $V_{DD} = 5\text{V}$		13.5		mA
Output sink current	$I_{sink_{PWM}}$	$V_{out,L} = 0.8\text{V}$, $V_{DD} = 3\text{V}$		13.5		mA

Output settling time	Tset V _{DD} = 5V	100 pF capacitive load, full operating Ta range , V _{DD} = 5V		500		ns
Output settling time	Tset V _{DD} = 3V	100 pF capacitive load, full operating Ta range , V _{DD} = 3V			150	ns
Output settling time	Tset _{RC} V _{DD} = 5V	220 Ohm in series with 47nF load on the wire, full Ta operating range , V _{DD} = 5V	20		50	us
Output settling time	Tset _{RC} V _{DD} = 3V	220 Ohm in series with 47nF load on the wire, full Ta operating range , V _{DD} = 3V		500		ns

Parameter	Symbol	Test Conditions	Min	Typ	Max	Units
SMBus compatible 2-wire interface²						
Input high voltage	V _{IH}		1.8	2	2.2	V
Input high voltage	V _{IH}		1.6	2	2.4	V
Input high voltage	V _{IH} (Ta,V)	Over temperature and supply	1.6		2.4	V
Input high voltage	V _{IH} (Ta,V)	Over temperature and supply	1.2	2	2.8	V
Input low voltage	V _{IL}		0.7	1.0	1.3	V
Input low voltage	V _{IL} (Ta,V)	Over temperature and supply	0.5		1.5	V
Output low voltage	V _{OL}	SDA pin in open drain mode, over temperature and supply, Isink = 2mA			0.2	V
SCL leakage	I _{SCL,leak}	V _{SCL} =4V, Ta=+85°C			30	uA
SDA leakage	I _{SDA,leak}	V _{SDA} =4V, Ta=+85°C			0.3	uA
SCL capacitance	C _{SCL}				10	pF
SDA capacitance	C _{SDA}				10	pF
Slave address	SA	Factory default		5Ah		hex
SMBus Request	t _{REQ}	SCL low	1.024			ms
Timeout, low	T _{imeout,L}	SCL low			30	ms
Timeout, high	T _{imeout,H}	SCL high			50	us
Acknowledge setup time	T _{suac} (MD)	8-th SCL falling edge, Master	0.5		1.5	us
Acknowledge hold time	T _{hdac} (MD)	9-th SCL falling edge, Master	1.5		2.5	us
Acknowledge setup time	T _{suac} (SD)	8-th SCL falling edge, Slave	2.5			us
Acknowledge hold time	T _{hdac} (SD)	9-th SCL falling edge, Slave	1.5			us
EEPROM						
Data retention		Ta = +85°C	10			years
Erase/write cycles		Ta = +25°C	100,000			Times
Erase/write cycles		Ta = +125°C	10,000			Times
Erase cell time	T _{erase}			5		ms
Write cell time	T _{write}			5		ms

Notes: All communication and refresh rate timings are given for the nominal calibrated HFO frequency and will vary with this frequency's variations.

1. All PWM timing specifications are given for single PWM output. For the extended PWM output each period has twice the timing specifications (refer to the PWM detailed description section). With large capacitive load lower PWM frequency is recommended. PWM is free-running, power-up factory default is SMBus.

2. SMBus compatible interface is described in details in the SMBus detailed description section.

All voltages are referred to the Vss (ground) unless otherwise noted.

3.1 RAM Registers 32 x 17bit for Data Readout

The RAM memory can only be read. Only a limited number of RAM registers are of interest to the customer.

Name	Address	Read access
Reserved	000h	Yes
...
Reserved	003h	Yes
V _{TP1} (sensor voltage of thermopile sensor 1)	004h	Yes
V _{TP2} (sensor voltage of thermopile sensor 2)	005h	Yes
T _A (linearized sensor case temperature)	006h	Yes
T _{O1} (linearized object temperature sensor 1)	007h	Yes
T _{O2} (linearized object temperature sensor 2)	008h	Yes
Reserved	009h	Yes
...
Reserved	01Fh	Yes

3.1.1 Sensor Voltage V_{TP}

An implemented chopper amplifier with programmable gain is used for the amplification of sensor voltages. Raw data of infrared channel 1 and, if equipped with 2 sensors, of infrared channel 2 are available in RAM cells VTP1 and VTP2. The sensor voltages can be calculated from RAM content based on following equations:

$$\begin{aligned} \text{VTP1reg} < 32768 \text{ (0x8000)} : & \quad \text{VTP1[mV]} = \text{VTP1reg} * 0.02932 \\ \text{VTP1reg} \geq 32768 \text{ (0x8000)} : & \quad \text{VTP1[mV]} = (\text{VTP1reg} - 32768) * -0.02932 \end{aligned}$$

The calculation results have the gain factor included.

3.1.2 Object Temperature T_O

To is the object temperature derived from thermopile and ambient sensor outputs as absolute (Kelvin) temperature. These calculations are done by the internal DSP, which produces digital outputs, linearly proportional to measured temperatures.

The result has a resolution of 0.02 °C and is available in RAM. To can be calculated from RAM as:

$$T_O [^{\circ}\text{K}] = T_O \text{reg} \times 0.02 \rightarrow 0.02 \text{ } ^{\circ}\text{K} / \text{LSB}$$

T_{O1} and T_{O2} are respective temperatures derived from thermopile sensor 1 and if equipped with 2 sensors from thermopile sensor 2 as well.

3.1.3 Ambient Temperature T_A

The Sensor die temperature is measured with a PTAT element. All the sensors' conditioning and data processing is handled on-chip and the linearized sensor die temperature T_A is made available in RAM memory.

The resolution of the calculated temperature is 0.02 °C. The sensor is factory calibrated for the temperature range (-40 to 125 °C). In RAM cell 006h, 2DE4h corresponds to -38.2 °C (linearization output lower limit) and 4DC4h (19908d) corresponds to 125 °C. The conversions from RAM content to real T_A can be done using the following relation:

$$T_A [^{\circ}\text{K}] = T_A \text{reg} \times 0.02 \rightarrow 0.02 \text{ } ^{\circ}\text{K} / \text{LSB}$$

3.2 EEPROM Memory 32 x 16bit for Parameter Change

A limited number of addresses in the EEPROM memory can be changed by the customer. The whole EEPROM can be read via SMBus interface.

Every change in EEPROM requires a reset of the device to enable the new value.

Name	Address	Write access
T _{Omax}	000h	Yes
T _{Omin}	001h	Yes
PWMCTRL	002h	Yes
T _A range	003h	Yes
Emissivity correction coefficient Ke	004h	Yes
Config Register1	005h	Yes

	Reserved	006h	No

	Reserved	00Dh	No
SMBus address		00Eh	Yes
Reserved, do not alter to keep the factory calibration relevant for the internal object temperature calculation		00Fh	Yes
	Reserved	010h	No

	Reserved	018h	No
Reserved, do not alter to keep the factory calibration relevant for the internal object temperature calculation		019h	Yes
	Reserved	01Ah	No
	Reserved	01Bh	No
	ID number	01Ch	No
	ID number	01Dh	No
	ID number	01Eh	No
	ID number	01Fh	No

3.2.1 $T_{o_{max}}$, $T_{o_{min}}$, T_a range

The addresses $T_{o_{max}}$, $T_{o_{min}}$ and T_a range are for customer dependent object and ambient temperature ranges for PWM output.

3.2.2 Emissivity Correction Coefficient

The address "emissivity correction coefficient" contains the object emissivity used for the internal object temperature calculation. A changing of the emissivity correction coefficient is equivalent to a changing of the sensor gain factor. Factory default 1.000 = 65535 (0xFFFF) (16 bit)
Erase (write 0) must take place before write of desired data is made.

3.2.3 PWMCTRL

The address **PWMCTRL** consists of control bits for configuring the PWM/SDA pin:

Bit 0	Select the type of PWM mode:	1 - Single PWM, factory default for single sensor device	0 - Extended PWM, factory default for dual sensor device
Bit 1	Enable/disable the PWM:	1 - Enable PWM, disable SMBus	0 - Enable SMBus, disable PWM factory default
Bit 2	Configuration of the pin PWM:	1 - Push-Pull,	0 - Open Drain NMOS, factory default
Bit 3	Mode selection	1 - Thermo Relay,	0 - PWM, factory default
Bits[8:4]	Extended PWM configuration	Number of repetitions divided by 2 of sensor 1 and 2 in Extended PWM mode. The number of repetitions can vary from 0 to 62 times.	
Bits[15:9]	PWM period	PWM period 1.024* ms (Single PWM) or 2.048* ms (Extended PWM) multiplied by the number written in this place. (128 in case the number is 0.)	

* Values are for nominal HFO frequency

3.2.4 Config Register1

The address **ConfigRegister1** consists of control bits for configuring the analog and digital parts:

Bits[2:0]	- Configure coefficients of IIR digital filter:	Factory calibration, spike limitation, influencing time response on fast signal changing			
Bit 3	- Configure the type of ambient temperature sensor:	1 - PTC	0 - PTAT		
Bits[5:4]	- Configure the type of data transmitted through PWM:		<i>Bits[5:4]</i>	<i>Data 1</i>	<i>Data 2</i>
			00	T_a	IR 1
			01	T_a	IR 2
			11	IR 1	IR 2
		10	IR 2	Undefined not recommended for extended PWM mode	
Bit 6	- Define the number of IR	1 - 2 sensors	0 - 1 sensor		

sensors:																				
Bit 7	- Define the sign Ks ($K_s = d\alpha/dT_{obj}$) :	Reserved, do not alter to keep the factory calibration relevant for the internal object temperature calculation																		
Bits[10:8]	- Configure coefficient N of FIR digital filter:	Factory calibration, influencing time response and resolution																		
Bits[13:11]	Gain of IR input amplifier	Do not alter to keep the factory calibration relevant for the object temperature calculation <table border="1" data-bbox="785 450 1394 696"> <thead> <tr> <th>Bits[13:11]</th> <th>Gain</th> </tr> </thead> <tbody> <tr> <td>000</td> <td>1 (bypassed)</td> </tr> <tr> <td>001</td> <td>3</td> </tr> <tr> <td>010</td> <td>6</td> </tr> <tr> <td>011</td> <td>12.5</td> </tr> <tr> <td>100</td> <td>25</td> </tr> <tr> <td>101</td> <td>50</td> </tr> <tr> <td>110</td> <td>100</td> </tr> <tr> <td>111</td> <td>100</td> </tr> </tbody> </table>	Bits[13:11]	Gain	000	1 (bypassed)	001	3	010	6	011	12.5	100	25	101	50	110	100	111	100
Bits[13:11]	Gain																			
000	1 (bypassed)																			
001	3																			
010	6																			
011	12.5																			
100	25																			
101	50																			
110	100																			
111	100																			
Bits[15:14]	Factory calibration, do not alter																			

3.2.5 SMBus Address

Only the low byte of EEPROM cell **SMBus address** represents the address of the device. The high byte has no meaning. Any connected device will respond to address 0x00. Shipped devices are preset to address 0x5A by default.

4 SMBus compatible 2-wire protocol

The chip supports a 2 wires serial protocol, build with pins PWM/SDA and SCL.

- SCL – digital input, used as the clock for SMBus compatible communication. This pin has the auxiliary function for building an external voltage regulator. When the external voltage regulator is used, the 2-wire protocol is available only if the power supply regulator is overdriven.
- PWM/SDA – Digital input/output, used for both the PWM output of the measured object temperature(s) or the digital input/output for the SMBus. The pin can be programmed in EEPROM to operate as Push/Pull or open drain NMOS (open drain NMOS is factory default). In SMBus mode SDA is forced to open drain NMOS I/O, push-pull selection bit defines PWM/Thermal relay operation.

4.1 Functional description

The SMBus interface is a 2-wire protocol, allowing communication between the Master Device (MD) and one or more Slave Devices (SD). In the system only one master can be presented at any given time [1]. The digital sensor module can only be used as a slave device. Maximum number of devices on one bus is 127, higher pull-up currents are recommended for higher number of devices, faster bus data transfer rates, and increased reactive loading of the bus. It can work in both low-power and high-power SMBus communication.

Generally, the MD initiates the start of data transfer by selecting a SD through the Slave Address (SA).

The MD has read access to the RAM and EEPROM and write access to 9 EEPROM cells (at addresses 0x20h, 0x21h, 0x22h, 0x23h, 0x24h, 0x25h*, 0x2Eh, 0x2Fh, 0x39h). If the access to the device is a read operation it will respond with 16 data bits and 8 bit PEC only if its own slave address, programmed in internal EEPROM, is equal to the SA, sent by the master. The SA feature allows connecting up to 127 devices with only 2 wires, unless the system has some of the specific features described in paragraph 5.2 of reference [1]. In order to provide access to any device or to assign an address to a SD before it is connected to the bus system, the communication must start with zero SA followed by low RWB bit. When this command is sent from the MD, the SD will always respond and will ignore the internal chip code information.

Special care must be taken not to put devices with same SD addresses on the same bus as it does not support ARP[1]. The MD can force sensor module into low consumption mode "sleep mode" (3V version only).

Read flags like "EEBUSY" (1 – EEPROM is busy with executing the previous write/erase), "EE_DEAD" (1 – there is fatal EEPROM error and this chip is not functional**).

Note*: This address is readable and writable. Bit 3 should not be altered as this will cancel the factory calibration.

Note**: EEPROM error signaling is implemented in automotive grade parts only.

4.2 Differences with the standard SMBus specification

There are eleven command protocols for standard SMBus interface. The sensor module supports only two of them. Not supported commands are:

- Quick Command
- Byte commands - Sent Byte, Receive Byte, Write Byte and Read Byte
- Process Call

- Block commands – Block Write and Write-Block Read Process Call

Supported commands are:

- Read Word
- Write Word

Reference for SMBus Specification:

System Management Bus (SMBus) Specification Version 2.0 August 3, 2000

SBS Implementers Forum Copyright . 1994, 1995, 1998, 2000

Duracell, Inc., Energizer Power Systems, Inc., Fujitsu, Ltd., Intel Corporation, Linear Technology Inc., Maxim Integrated Products, Mitsubishi Electric Semiconductor Company, PowerSmart, Inc., Toshiba Battery Co. Ltd., Unitrode Corporation, USAR Systems, Inc.

4.3 Detailed description

The PWM/SDA pin can operate also as PWM output, depending on the EEPROM settings. If PWM is enabled, after POR the PWM/SDA pin is directly configured as PWM output. The PWM mode can be avoided and the pin can be restored to its Data function by a special command. That is why hereafter both modes are treated separately.

4.3.1 Bus Protocol

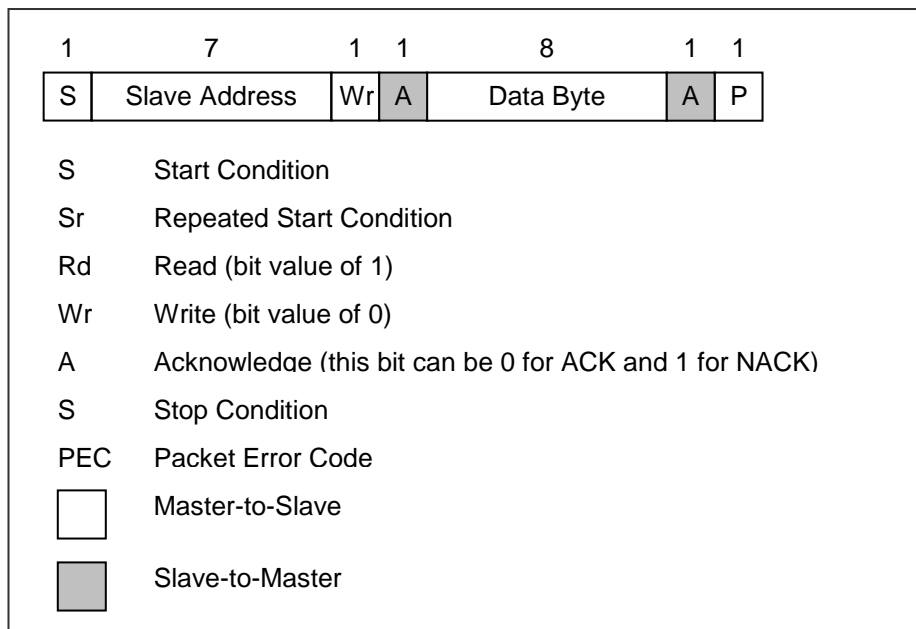

After every 8 bits received by the SD an ACK/NACK takes place. When a MD initiates communication, it first sends the address of the slave and only the SD which recognizes the address will ACK, the rest will remain silent. In case the SD NACKs one of the bytes, the MD should stop the communication and repeat the message. A NACK could be received after the PEC. This means that there is an error in the received message and the MD should try sending the message again. The PEC calculation includes all bits except the START, REPEATED START, STOP, ACK, and NACK bits. The PEC is a CRC-8 with polynomial X^8+X^2+X+1 . The Most Significant Bit of every byte is transferred first.

4.3.2 Packet Error Code (PEC) Calculation

A packet error checking mechanism according to SMBus specification version 1.1 is implemented.

The packet error checking of SMBus devices uses an 8-bit cyclic redundancy check (CRC-8) to calculate the PEC.

The polynomial used is $C(x) = 10000111$ ($= x^8 + x^2 + x + 1$).

The PEC calculation includes all bytes in the transmission, including address, command and data. It does not include ACK, NACK, START, STOP bits.

4.3.3 Read Word (depending on the command – RAM or EEPROM)

Format of SMBus reading:

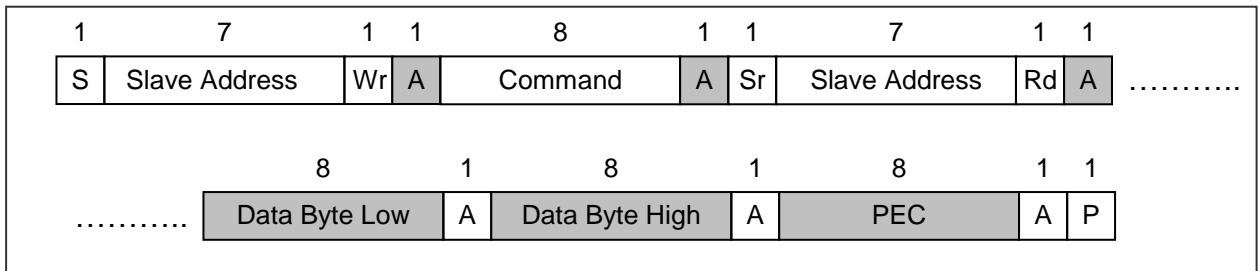

Any device will respond to address zero.

The read data from RAM are divided by two due to MSB as sign bit or error flag.

For linearized temperatures (T_{O1} , T_{O2} , T_A) the MSB is an error flag (active high). For voltage raw data (V_{TP1} , V_{TP2}) the MSB is a sign bit.

Please note after POR additional delay is needed before first reading can be started.

Read operation flow diagram:

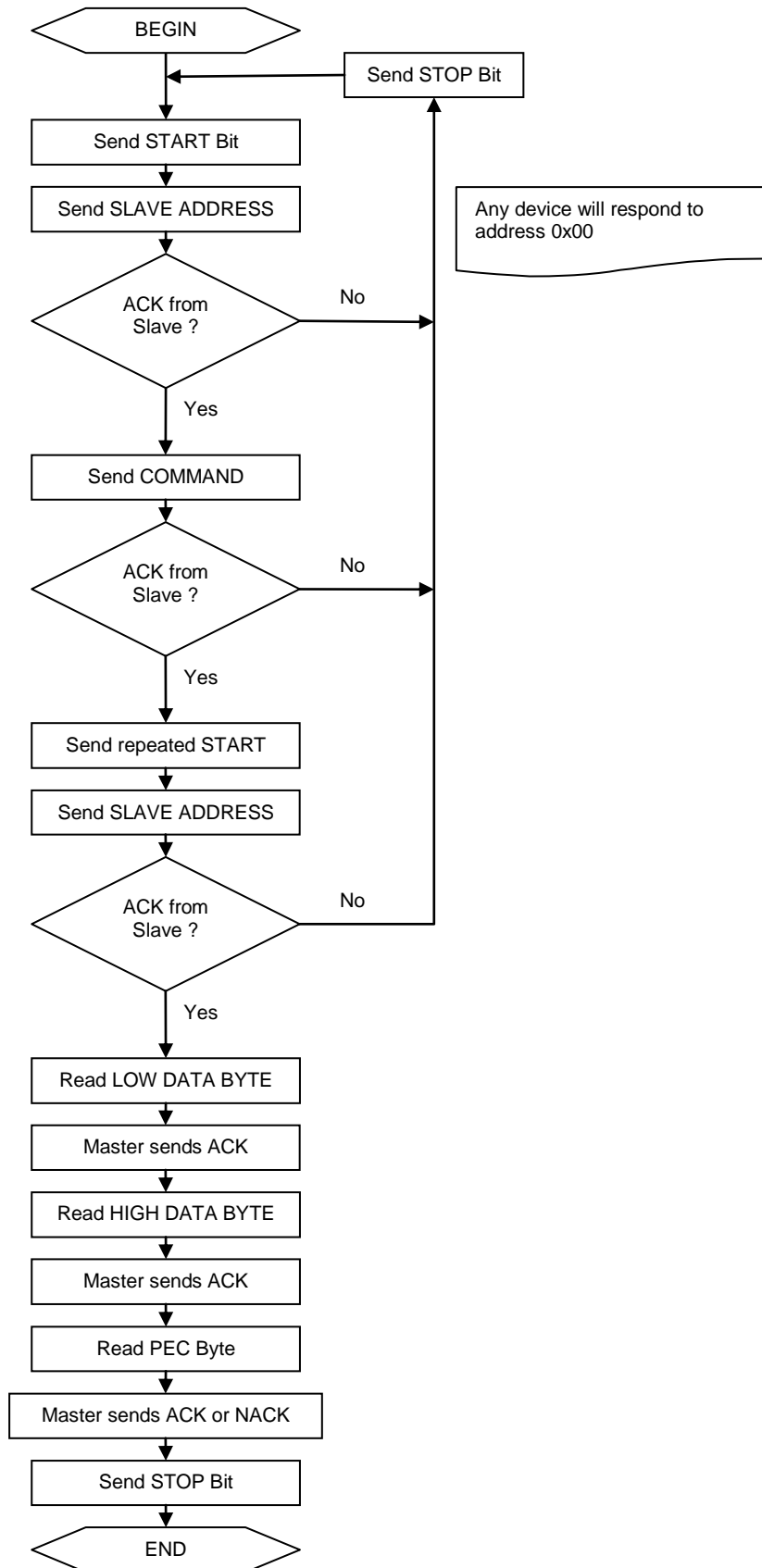

Pseudo code example read RAM address 0x07 (T₀₁):

1. Send START Bit

2. Send Slave Address (0x5A by default) + Rd/Wr bit (Rd/Wr bit -> 0 or 1)
3. Send Command (0b000x_xxxx + 0b0000_0111 -> 0b0000_0111)
4. Send Repeated START bit
5. Send Slave address + Rd/Wr bit (Rd/Wr bit -> 0 or 1)
6. Read Data byte low (send ACK -> 0 by master)
7. Read Data byte high (send ACK -> 0 by master)
8. Read PEC (ACK -> 0 or NACK -> 1 from master)
9. Send Stop bit

Pseudo code example read EEPROM address 0x0E (SMBus Address):

1. Send START Bit
2. Send Slave Address (0x5A by default) + Rd/Wr bit (Rd/Wr bit -> 0 or 1)
3. Send Command (0b001x_xxxx + 0b0000_1110 -> 0b0010_1110)
4. Send Repeated START bit
5. Send Slave address + Rd/Wr bit (Rd/Wr bit -> 0 or 1)
6. Read Data byte low (send ACK -> 0 by master)
7. Read Data byte high (send ACK -> 0 by master)
8. Read PEC (ACK -> 0 or NACK -> 1 from master)
9. Send Stop bit

4.3.4 Write Word (depending on the command – RAM or EEPROM)

Format of SMBus writing:

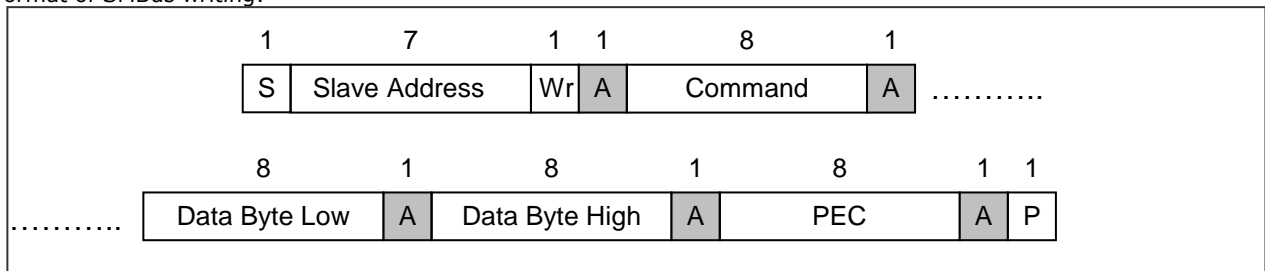

Any device will respond to address zero.

RAM memory is read only.

All EEPROM cells are accessible for reading. In application mode 9 cells of the EEPROM can be changed only. An attempt to write in one of the other EEPROM cells will have no result.

Before changing of cell contents the respective cells need to be erased. Erasing is a writing of zeros to the respective EEPROM address. After writing operation the device needs 5ms to process the new values.

After changing of EEPROM content it is strongly recommended to restart the device by power off/on or by sleep operation on/off.

Pseudo code example write EEPROM address 0x0E (SMBus Address):

Erasing:

1. Send START Bit
2. Send Slave Address (0x5A by default) + Rd/Wr bit (Rd/Wr bit -> 0 or 1)
3. Send Command (0b001x_xxxx + 0b0000_1110 -> 0b0010_1110)
4. Send Data byte low (0x00 for erasing)
5. Send Data byte high (0x00 for erasing)
6. Send PEC 0x6F
7. Send Stop bit
8. Wait 5ms

Writing of 0x5A:

9. Send START Bit
10. Send Slave Address (0x5A by default) + Rd/Wr bit (Rd/Wr bit -> 0 or 1)
11. Send Command (0b001x_xxxx + 0b0000_1110 -> 0b0010_1110)
12. Send Data byte low (0x5A)
13. Send Data byte high (0x00)
14. Send PEC 0xE1
15. Send Stop bit
16. Wait 5ms
17. Reset of the device

Write operation flow diagram:

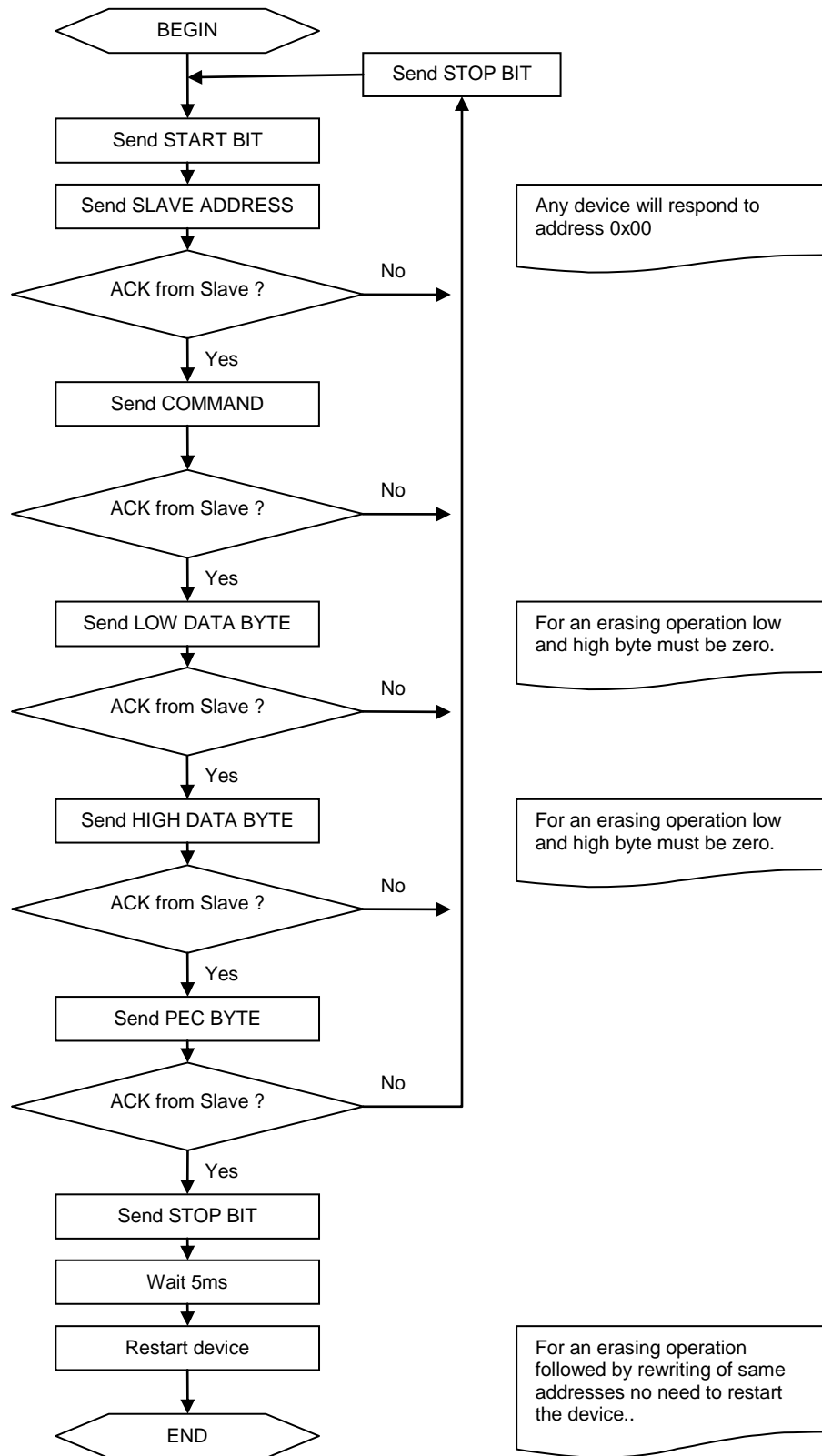

4.4 AC specification for SMBus

4.4.1 Timing

The sensor module meets all the timing specifications of the SMBus [1]. The maximum frequency of the sensor module's SMBus is 100 KHz and the minimum is 10 KHz.

The specific timings in the module's SMBus are:

SMBus Request (t_{REQ}) is the time that the SCL should be forced low in order to switch the device from PWM mode to SMBus mode;

Timeout_L is the maximum allowed time for SCL to be low. After this time the sensor module will reset its communication block and will be ready for new communication;

Timeout_H is the maximum time for which it is allowed for SCL to be high during communication. After this time sensor module will reset its communication block assuming that the bus is idle (according to the SMBus specification).

$T_{suac}(SD)$ is the time after the eighth falling edge of SCL that will force PWM/SDA low to acknowledge the last received byte.

$T_{hdac}(SD)$ is the time after the ninth falling edge of SCL that will release the PWM/SDA (so the MD can continue with the communication).

$T_{suac}(MD)$ is the time after the eighth falling edge of SCL that will release PWM/SDA (so that the MD can acknowledge the last received byte).

$T_{hdac}(MD)$ is the time after the ninth falling edge of SCL that will take control of the PWM/SDA (so it can continue with the next byte to transmit).

The indexes MD and SD for the latest timings are used – MD when the master device is making acknowledge; SD when the slave device is making acknowledge-. For other timings see [1].

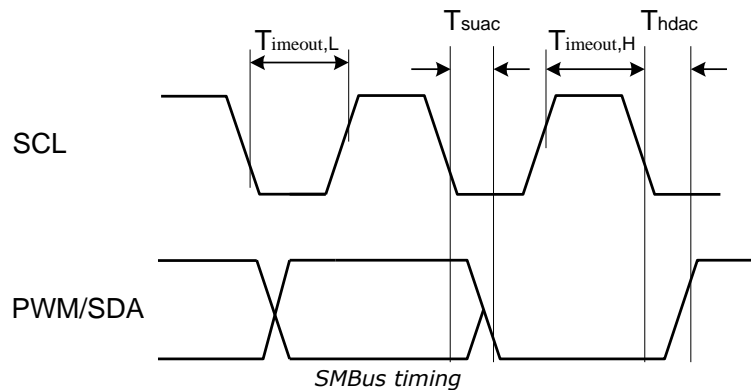

4.4.2 Bit transfer

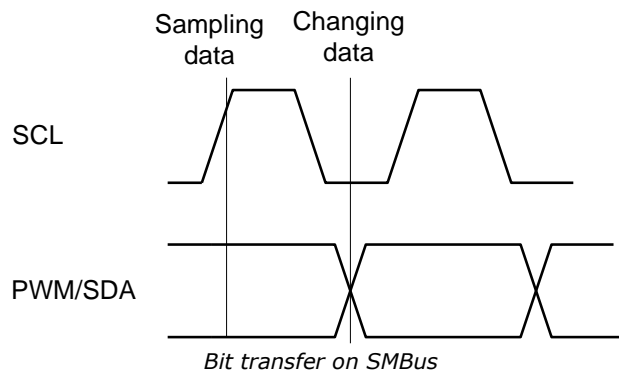

The data on PWM/SDA must be changed when SCL is low (min 300ns after the falling edge of SCL). The data is fetched by both MD and SDs on the rising edge of the SCL.

4.4.3 Commands

RAM and EEPROM can be read both with 32x16 sizes. If the RAM is read, the data are divided by two, due to a sign bit in RAM (for example, T_{OBJ1} - RAM address 0x07h will sweep between 0x27ADh to 0x7FFF as the object temperature rises from -70.01°C to +382.19°C). The MSB read from RAM is an error flag (active high) for the linearized temperatures (T_{OBJ1} , T_{OBJ2} and T_a). The MSB for the raw data (e.g. IR sensor1 data) is a sign bit (sign and magnitude format). A write of 0x0000 must be done prior to writing in EEPROM in order to erase the EEPROM cell content. Refer to EEPROM detailed description for factory calibration EEPROM locations that need to be kept unaltered.

Opcode	Command
000x xxxx*	RAM Access
001x xxxx*	EEPROM Access
1111_0000**	Read Flags
1111_1111	Enter SLEEP mode

Note*: The xxxxx represent the 5 LSBits of the memory map address to be read/written.

Note**: Behaves like read command. The sensor module returns PEC after 16 bits data of which only 4 are meaningful and if the MD wants it, it can stop the communication after the first byte. The difference between read and read flags is that the latter does not have a repeated start bit.

Flags read are:

Data[7] - EEBUSY - the previous write/erase EEPROM access is still in progress. High active.

Data[6] - Unused

Data[5] - EE_DEAD - EEPROM double error has occurred. High active.

Data[4] - INIT - POR initialization routine is still ongoing. Low active.

Data[3] - Not implemented.

Data[2..0] and Data[8..15] - All zeros.

Flags read is a diagnostic feature. The sensor module can be used regardless of these flags.

5 PWM

The sensor module can be read via PWM or SMBus compatible interface. Selection of PWM output is done in EEPROM configuration (factory default is SMBus). PWM output has two programmable formats, single and dual data transmission, providing single wire reading of two temperatures (dual zone object or object and ambient). The PWM period is derived from the on-chip oscillator and is programmable.

PWM period configuration: Period in extended PWM mode is twice the period in single PWM mode.

In single PWM mode period is $T = 1.024 * P$ [ms], where P is the number, written in bits 15..9 PWMCTRL. Maximum period is then 131.072 ms for single and 262.144 ms for extended. These values are typical and depend on the on-chip RC oscillator absolute value. The duty cycle must be calculated instead of working only with the high time only in order to avoid errors from the period absolute value deviations.

Config Register[5:4]	PWM1 data	PWM2 data	Tmin,1	Tmax,1	Tmin,2	Tmax,2
00	Ta	Tobj1	Ta _{range,L}	Ta _{range,H}	TO _{min}	TO _{max}
01	Ta	Tobj2	Ta _{range,L}	Ta _{range,H}	TO _{min}	TO _{max}
11	Tobj1	Tobj2	TO _{min}	TO _{max}	TO _{min}	TO _{max}
10*	Tobj2	Undefined	TO _{min}	TO _{max}	N.A.	N.A.

Note: Serial data functions (2-wire / PWM) are multiplexed with a thermal relay function (described in the "Thermal relay" section).

* not recommended for extended PWM format operation

5.1 Single PWM format

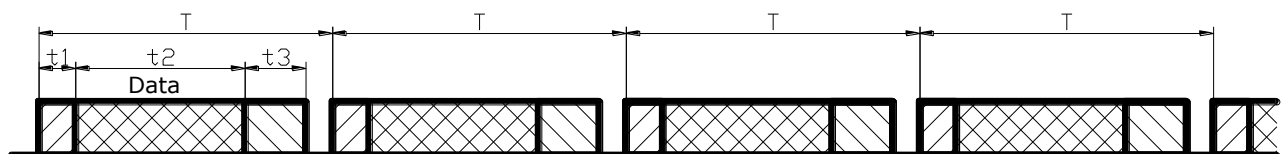

Single PWM Output Format



Single PWM output format

In single PWM output mode the settings for PWM1 data only are used. The temperature reading can be calculated from

the signal timing as:
$$T_{out} = \left[\frac{2t_2}{T} * (T_{max} - T_{min}) \right] + T_{min}$$

where T_{min} and T_{max} are the corresponding rescale coefficients in EEPROM for the selected temperature output (T_a , object temperature range is valid for both T_{obj1} and T_{obj2} as specified in the previous table) and T is the PWM period. T_{out} is T_{obj1} , T_{obj2} or T_a according to Config Register [5:4] settings.

The different time intervals t_1 - t_3 have the following functions:

t_1 : Start buffer. During this time the signal is always high. $t_1 = 0.125 * T$ (T is the PWM period, refer to fig. 11).

t_2 : Valid Data Output Band, 0 to $1/2T$. PWM output data resolution is 10 bit.

t_3 : Error band – information for fatal error in EEPROM (double error detected, not correctable). $t_3 = 0.25 * T$. Therefore a PWM pulse train with a duty cycle of 0.875 will indicate a fatal error in EEPROM (for single PWM format).

Example:

$T_{obj1} \Rightarrow$ Config Reg[5:4] = 11'b

$T_{min} = 0^\circ\text{C} \Rightarrow T_{min} [\text{EEPROM}] = 100 * (t_{o_{min}} + 273.15) = 6AB3h$

$T_{max} = +50^\circ\text{C} \Rightarrow T_{max} [\text{EEPROM}] = 100 * (t_{o_{max}} + 273.15) = 7E3Bh$

Captured PWM high duration is $0.495 * T \Rightarrow t_2 = (0.495 - 0.125) * T = 0.370 * T \Rightarrow$

measured object temperature = $2 * 0.370 * (50^\circ\text{C} - 0^\circ\text{C}) + 0^\circ\text{C} = +37.0^\circ\text{C}$.

5.2 Extended PWM format

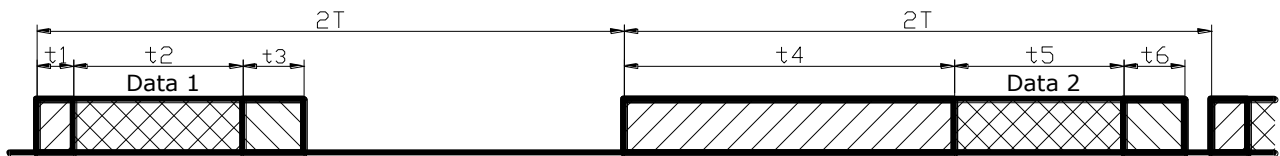

Extended PWM Output Format



Extended PWM output format

Note that with bits $DUAL[5:1] > 00h$ each period will be outputted $2N+1$ times, where N is the decimal value of the number written in $DUAL[5:1]$ ($DUAL[5:1] = \text{PWM control \& clock } [8:4]$).

The temperature transmitted in Data 1 field can be calculated using the following equation:

$$T_{out1} = \left[\frac{2t_2}{T} * (T_{max1} - T_{min1}) \right] + T_{min1}$$

For Data 2 field the equation is:

$$T_{out2} = \left[\frac{2t_5}{T} * (T_{max2} - T_{min2}) \right] + T_{min2}$$

Where T_{min1} , T_{max1} , T_{min2} and T_{max2} are given in Table 9, $t_2 = t_{high1} - t_1$, and $t_5 = t_{high2} - t_4$.

Time bands are: $t_1 = 0.125 * T$, $t_3 = 0.25 * T$ and $t_4 = 1.125 * T$. As shown in Figure 11, in extended PWM format the period is twice the period for the single PWM format. All equations provided herein are given for the single PWM period T . The EEPROM Error band signaling will be 43.75% duty cycle for Data1 and 93.75% for Data2.

Note: EEPROM error signaling is implemented in automotive grade parts only.

Example:

Configuration: $T_a : T_{obj1} @ \text{Data1} : \text{Data2} \Rightarrow$ Config Reg[5:4] = 00b,

$T_{min} = -5^\circ\text{C} \Rightarrow T_{range, L} [\text{EEPROM}] = 100 * (T_{min} + 38.2) / 64 = 34h$,

$T_{max} = +105^\circ\text{C} \Rightarrow T_{range, H} [\text{EEPROM}] = 100 * (T_{max} + 38.2) / 64 = E0h$,

$T_{range} [\text{EEPROM}] = E034h$

$T_{min} = 0^\circ\text{C} \Rightarrow T_{min} [\text{EEPROM}] = 100 * (T_{min} + 273.15) = 6AB3h$

$T_{max} = +50^\circ\text{C} \Rightarrow T_{max} [\text{EEPROM}] = 100 * (T_{max} + 273.15) = 7E3Bh$

Captured high durations are $0.13068 * (2T)$ and $0.7475 * (2T)$, where $2T$ is each captured PWM period. Time band t_4 is provided for reliable determination between Data1 and Data2 data fields. Thus Data1 is represented by $0.13068 * (2T)$ and Data2 – by $0.7475 * (2T)$, and the temperatures can be calculated as follows:

$t_2/T = (t_{high1}/T) - 0.125 = 0.13636 \Rightarrow T_a = +25.0^\circ\text{C}$,

$t_5/T = (t_{high2}/T) - 1.125 = 0.370 \Rightarrow T_{obj1} = +37.0^\circ\text{C}$.

5.3 Customizing the temperature range for PWM output

The calculated ambient and object temperatures are stored in RAM with a resolution of 0.01 °C (16 bit). The PWM operates with a 10-bit word so the transmitted temperature is rescaled in order to fit in the desired range. For this goal 2 cells in EEPROM are foreseen to store the desired range for To (To_{min} and To_{max}) and one for Ta (Ta_{range}): the 8MSB are foreseen for Ta_{max} and the 8LSB for Ta_{min}. Thus the output range for To can be programmed with an accuracy of 0.01 °C, while the corresponding Ta range can be programmed with an accuracy of 2.56 °C.

The **object** data for PWM is rescaled according to the following equation:

$$T_{PWM_{obj}} = \frac{T_{RAM} - T_{MIN_{EEPROM}}}{K_{PWM_{obj}}}, K_{PWM_{obj}} = \frac{T_{MAX_{EEPROM}} - T_{MIN_{EEPROM}}}{1023}$$

The T_{RAM} is the linearized Tobj, 16-bit (0000..FFFFh, 0000 for -273.15°C and FFFFh for +382.2°C) and the result is a 10-bit word, in which 000h corresponds to To_{MIN}[°C], 3FFh corresponds to To_{MAX}[°C] and 1LSB corresponds to $\frac{T_{O_{MAX}} - T_{O_{MIN}}}{1023}$ [°C]

$$T_{MIN_{EEPROM}} = T_{MIN} * 100 \text{ LSB}$$

$$T_{MAX_{EEPROM}} = T_{MAX} * 100 \text{ LSB}$$

The **ambient** data for PWM is rescaled according to the following equation:

$$T_{PWM_{ambient}} = \frac{T_{RAM} - T_{MIN_{EEPROM}}}{K_{PWM_{ambient}}}, K_{PWM_{ambient}} = \frac{T_{MAX_{EEPROM}} - T_{MIN_{EEPROM}}}{1023}$$

The result is a 10-bit word, where 000h corresponds to -38.2 °C (lowest Ta that can be read via PWM), 3FFh corresponds to 125 °C (highest Ta that can be read via PWM) and 1LSB corresponds to $\frac{T_{MAX} - T_{MIN}}{1023}$ [°C]

$$T_{MIN_{EEPROM}} = \lfloor T_{MIN} - \lceil 38.2 \rceil \rceil * \frac{100}{64} \text{ LSB}$$

$$T_{MAX_{EEPROM}} = \lfloor T_{MAX} - \lceil 38.2 \rceil \rceil * \frac{100}{64} \text{ LSB}$$

6 Switching Between PWM and SMBus communication

6.1 PWM is enabled

The diagram below illustrates the way of switching to SMBus if PWM is enabled (factory programmed POR default is SMBus, PWM disabled). Note that the SCL pin needs to be kept high in order to use PWM.

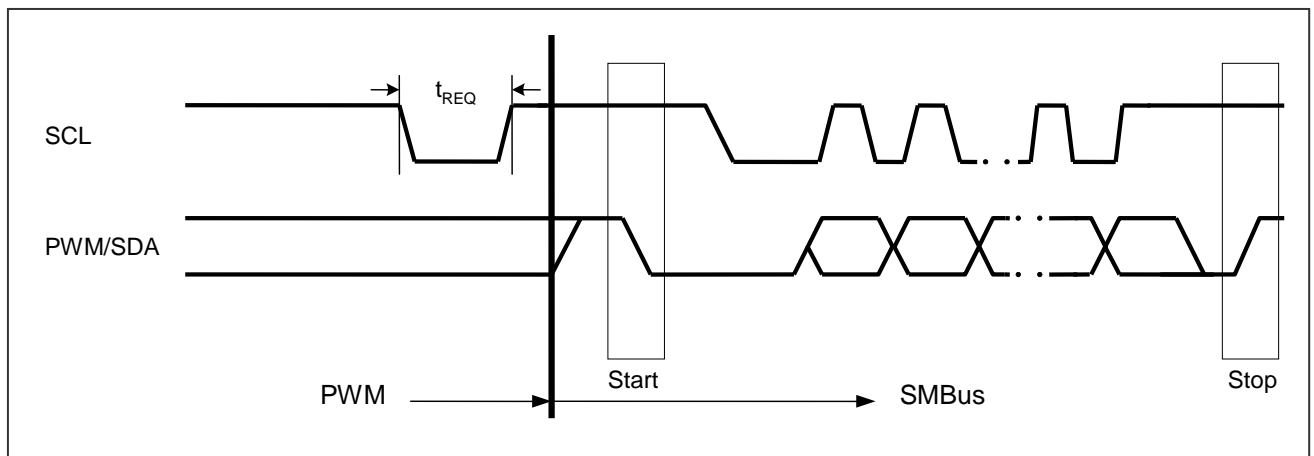

Switching from PWM mode to SMBus

6.2 Request condition

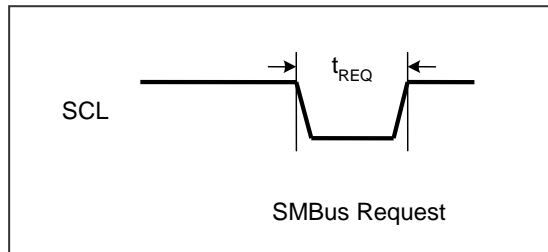

Request (switch to SMBus) condition

If PWM is enabled, the SMBus Request condition is needed to disable PWM and reconfigure PWM/SDA pin before starting SMBus communication. Once PWM is disabled, it can be only enabled by switching the supply Off-On or exit from Sleep Mode. The SMBus request condition requires forcing LOW the SCL pin for period longer than the request time (t_{REQ}). The SDA line value is ignored in this case.

6.3 PWM is disabled

If PWM is disabled by means of EEPROM the PWM/SDA pin is directly used for the SMBus purposes after POR. **Request condition should not be sent in this case.**

7 Disclaimer of Liability

All documents are prepared in all conscience. Parts of the pages or the complete publication including all offers and information might be extended, changed or partly or completely deleted without separate announcement. Liability claims regarding damage caused by the use of any information or related product provided, including any kind of information which is incomplete or incorrect, will be rejected. Changes or modifications at products assembled or distributed by Heimann Sensor or their representatives haven't to be announced to customers in advance. Exceptions need to be contracted before obtaining of products. Customers are requested to consult with Heimann Sensor representatives before the use of Heimann Sensor products in applications where failure or abnormal operation may directly affect human lives or cause physical injury or property damage. The company or their representatives will not be responsible for damage arising from such use.